

Mini SIDELED

LS C870, LO C870, LY C870, LG C870, LP C870



Nicht für Neuentwicklungen - wird durch Micro SIDELED ersetzt werden
Not for new designs - will be replaced by Micro SIDELED

Besondere Merkmale

- **Gehäusetypp:** weißes SMT-Gehäuse
- **Besonderheit des Bauteils:** kleine Bauform mit extrem breiter Abstrahlcharakteristik; ideal für Einkopplungen in Lichtleiter
- **Wellenlänge:** 628 nm (super-rot), 605 nm (orange), 587 nm (gelb), 570 nm (grün), 560 nm (pure green)
- **Abstrahlwinkel:** Lambertscher Strahler (120°)
- **Technologie:** GaAIP (super-rot, orange, gelb, grün), GaP (pure green)
- **optischer Wirkungsgrad:** 1,5 lm/W (super-rot, orange, gelb), 2,5 lm/W (grün), 0,6 lm/W (pure green)
- **Gruppierungsparameter:** Lichtstärke
- **Verarbeitungsmethode:** für alle SMT-Bestücktechniken geeignet
- **Lötmethode:** IR Reflow Löten
- **Vorbehandlung:** nach JEDEC Level 2
- **Gurtung:** 12-mm Gurt mit 2500/Rolle, ø180 mm oder 10000/Rolle, ø330 mm

Anwendungen

- optischer Indikator
- Hinterleuchtung (LCD, Handy, Schalter, Tasten, Displays, Werbebeleuchtung, Allgemeinbeleuchtung)
- Markierungsbeleuchtung (z.B. Stufen, Fluchtwege, u.ä.)
- Innenbeleuchtung im Automobilbereich (z.B. Instrumentenbeleuchtung, u.ä.)
- Einkopplung in Lichtleiter

Features

- **package:** white SMT package
- **feature of the device:** small package with extremely wide viewing angle; ideal for coupling in light guides
- **wavelength:** 628 nm (super-red), 605 nm (orange), 587 nm (yellow), 570 nm (green), 560 nm (pure green)
- **viewing angle:** Lambertian Emitter (120°)
- **technology:** GaAIP (super-red, orange, yellow, green), GaP (pure green)
- **optical efficiency:** 1.5 lm/W (super-red, orange, yellow), 2.5 lm/W (green), 0.6 lm/W (pure green)
- **grouping parameter:** luminous intensity
- **assembly methods:** suitable for all SMT assembly methods
- **soldering methods:** IR reflow soldering
- **preconditioning:** acc. to JEDEC Level 2
- **taping:** 12-mm tape with 2500/reel, ø180 mm or 10000/reel, ø330 mm

Applications

- optical indicators
- backlighting (LCD, cellular phones, switches, keys, displays, illuminated advertising, general lighting)
- marker lights (e.g. steps, exit ways, etc.)
- Interior automotive lighting (e.g. dashboard backlighting, etc.)
- coupling into light guides

LS C870, LO C870, LY C870, LG C870, LP C870

Type	Emissions- farbe	Farbe der Lichtaustritts- fläche	Lichtstärke	Lichtstrom	Bestellnummer
Type	Color of Emission	Color of the Light Emitting Area	Luminous Intensity $I_F = 10 \text{ mA}$ $I_V \text{ (mcd)}$	Luminous Flux $I_F = 10 \text{ mA}$ $\Phi_V \text{ (mlm)}$	Ordering Code
LS C870-H2J2-1 LS C870-J2L1-1	super-red	colorless clear	3.55 ... 7.10 5.60 ... 14.00	15 (typ.) 28 (typ.)	Q62703-Q5079 Q62703-Q5080
LO C870-H2J2-1 LO C870-J2L1-1	orange	colorless clear	3.55 ... 7.10 5.60 ... 14.00	15 (typ.) 28 (typ.)	Q62703-Q5034 Q62703-Q5035
LY C870-H2J2-1 LY C870-J2L1-1	yellow	colorless clear	3.55 ... 7.10 5.60 ... 14.00	15 (typ.) 28 (typ.)	Q62703-Q5115 Q62703-Q5116
LG C870-J2K2-1 LG C870-K2M1-1	green	colorless clear	5.60 ... 11.20 9.00 ... 22.40	25 (typ.) 45 (typ.)	Q62703-Q5004 Q62703-Q5005
LP C870-F2G2-1 LP C870-G2J1-1	pure green	colorless clear	1.40 ... 2.80 2.24 ... 5.60	6.0 (typ.) 11.0 (typ.)	Q62703-Q5058 Q62703-Q5059

Anm.: -1 gesamter Farbbereich

Die Standardlieferform von Serientypen beinhaltet eine untere bzw. eine obere Familiengruppe, die aus nur 3 bzw. 4 Halbgruppen besteht. Einzelne Halbgruppen sind nicht erhältlich. In einer Verpackungseinheit / Gurt ist immer nur eine Halbgruppe enthalten.

Note: -1 Total color tolerance range

The standard shipping format for serial types includes a lower or upper family group of 3 or 4 individual groups. Individual half groups are not available. No packing unit / tape ever contains more than one luminous intensity half group.

Grenzwerte
Maximum Ratings

Bezeichnung Parameter	Symbol Symbol	Wert Value		Einheit Unit
		LS, LO, LY, LG	LP	
Betriebstemperatur Operating temperature range	T_{op}	- 40 ... + 100		°C
Lagertemperatur Storage temperature range	T_{stg}	- 40 ... + 100		°C
Sperrschichttemperatur Junction temperature	T_j	+ 100		°C
Durchlassstrom Forward current	I_F	30		mA
Stoßstrom Surge current $t \leq 10 \mu s, D = 0.005$	I_{FM}	0.5		A
Sperrspannung Reverse voltage	V_R	5		V
Leistungsaufnahme Power consumption	P_{tot}	95	90	mW
Wärmewiderstand Thermal resistance Sperrschicht/Umgebung Junction/ambient	$R_{th JA}$	530		K/W
Sperrschicht/Lötpad Junction/soldering point Montage auf PC-Board FR4 (Padgröße $\geq 16 \text{ mm}^2$) mounted on PC board FR4 (pad size $\geq 16 \text{ mm}^2$)	$R_{th JS}$	250		K/W

Kennwerte ($T_A = 25\text{ °C}$)

Characteristics

Bezeichnung Parameter	Symbol Symbol	Wert Value					Einheit Unit
		LS	LO	LY	LG	LP	
Wellenlänge des emittierten Lichtes (typ.) Wavelength at peak emission $I_F = 10\text{ mA}$	λ_{peak}	635	610	586	572	557	nm
Dominantwellenlänge ¹⁾ (typ.) Dominant wavelength ¹⁾ $I_F = 10\text{ mA}$	λ_{dom}	628 ± 6	606 ± 6	587 +8/-7	570 ± 6	560 ± 6	nm
Spektrale Bandbreite bei 50 % $I_{\text{rel max}}$ (typ.) Spectral bandwidth at 50 % $I_{\text{rel max}}$ $I_F = 10\text{ mA}$	$\Delta\lambda$	45	40	45	25	22	nm
Abstrahlwinkel bei 50 % I_V (Vollwinkel) (typ.) Viewing angle at 50 % I_V	2ϕ	120	120	120	120	120	Grad deg.
Durchlassspannung ²⁾ (typ.) Forward voltage ²⁾ (max.) $I_F = 10\text{ mA}$	V_F ²⁾ V_F	2.0 2.5	2.0 2.5	2.0 2.5	2.0 2.5	2.0 2.5	V V
Sperrstrom (typ.) Reverse current (max.) $V_R = 5\text{ V}$	I_R I_R	0.01 10	0.01 10	0.01 10	0.01 10	0.01 10	μA μA
Temperaturkoeffizient von λ_{peak} (typ.) Temperature coefficient of λ_{peak} $I_F = 10\text{ mA}; -10\text{ °C} \leq T \leq 100\text{ °C}$	$TC_{\lambda_{\text{peak}}}$	0.11	0.12	0.10	0.11	0.11	nm/K
Temperaturkoeffizient von λ_{dom} (typ.) Temperature coefficient of λ_{dom} $I_F = 10\text{ mA}; -10\text{ °C} \leq T \leq 100\text{ °C}$	$TC_{\lambda_{\text{dom}}}$	0.07	0.07	0.07	0.07	0.05	nm/K
Temperaturkoeffizient von V_F (typ.) Temperature coefficient of V_F $I_F = 10\text{ mA}; -10\text{ °C} \leq T \leq 100\text{ °C}$	TC_V	-1.9	-1.9	-1.9	-1.4	-2.1	mV/K
Optischer Wirkungsgrad (typ.) Optical efficiency $I_F = 10\text{ mA}$	η_{opt}	1.5	1.5	1.5	2.5	0.6	lm/W

¹⁾ Wellenlängen werden mit einer Stromeinprägungsdauer von 25 ms und einer Genauigkeit von $\pm 1\text{ nm}$ ermittelt.
Wavelengths are tested at a current pulse duration of 25 ms and a tolerance of $\pm 1\text{ nm}$.

²⁾ Spannungswerte werden mit einer Stromeinprägungsdauer von 1 ms und einer Genauigkeit von $\pm 0.1\text{ V}$ ermittelt.
Voltages are tested at a current pulse duration of 1 ms and a tolerance of $\pm 0.1\text{ V}$.

Helligkeits-Gruppierungsschema
Luminous Intensity Groups

Lichtgruppe Luminous Intensity Group	Lichtstärke Luminous Intensity I_v (mcd)	Lichtstrom Luminous Flux Φ_v (mlm)
F2	1.40 ... 1.80	60.0 (typ.)
G1	1.80 ... 2.24	75.0 (typ.)
G2	2.24 ... 2.80	95.0 (typ.)
H1	2.80 ... 3.55	120.0 (typ.)
H2	3.55 ... 4.50	150.0 (typ.)
J1	4.50 ... 5.60	190.0 (typ.)
J2	5.60 ... 7.10	240.0 (typ.)
K1	7.10 ... 9.00	300.0 (typ.)
K2	9.00 ... 11.20	380.0 (typ.)
L1	11.20 ... 14.00	480.0 (typ.)
L2	14.00 ... 18.00	600.0 (typ.)
M1	18.00 ... 22.40	760.0 (typ.)

Helligkeitswerte werden mit einer Stromeinprägedauer von 25 ms und einer Genauigkeit von $\pm 11\%$ ermittelt.
 Luminous intensity is tested at a current pulse duration of 25 ms and a tolerance of $\pm 11\%$.

Gruppenbezeichnung auf Etikett
Group Name on Label

Beispiel: K2
 Example: K2

Lichtgruppe Luminous Intensity Group	Halbgruppe Half Group
K	2

Relative spektrale Emission $I_{rel} = f(\lambda)$, $T_A = 25\text{ °C}$, $I_F = 10\text{ mA}$

Relative Spectral Emission

$V(\lambda)$ = spektrale Augenempfindlichkeit

Standard eye response curve

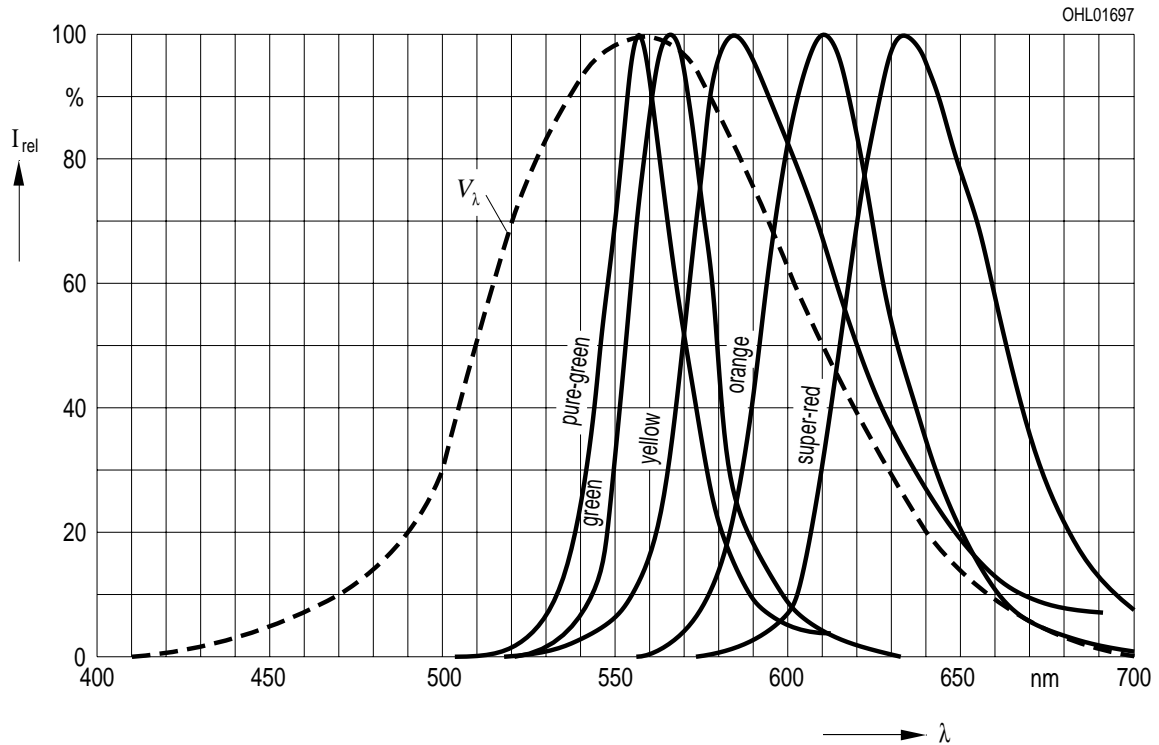

Abstrahlcharakteristik $I_{rel} = f(\varphi)$

Radiation Characteristic

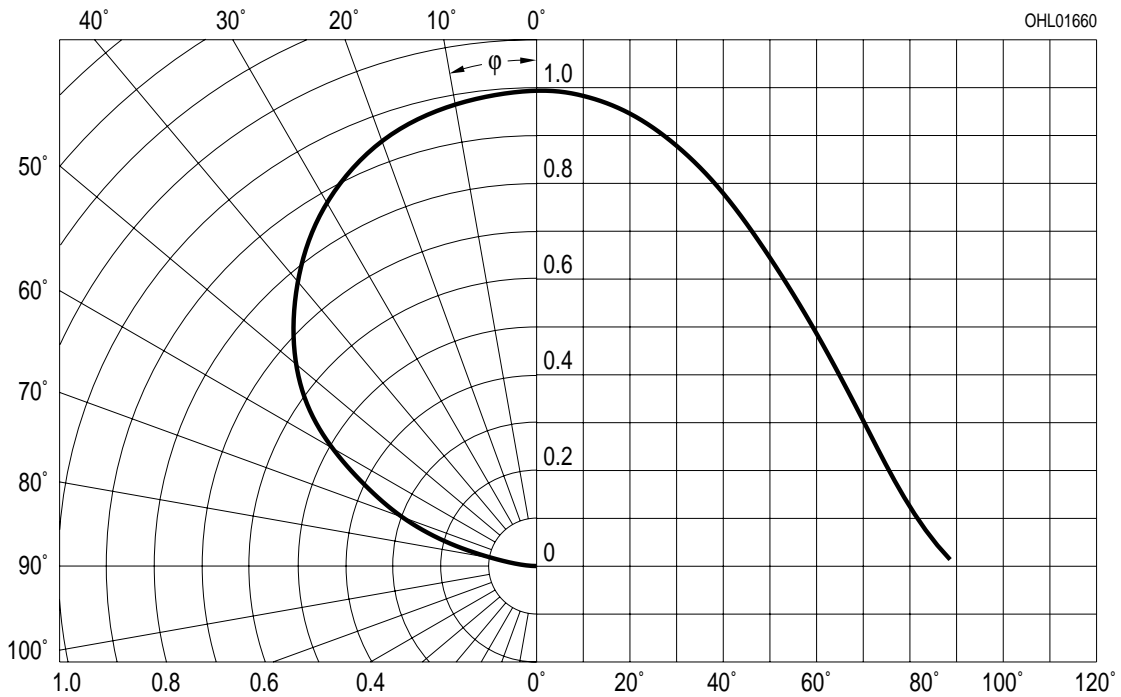

Durchlassstrom $I_F = f(V_F)$
Forward Current

$T_A = 25\text{ }^\circ\text{C}$

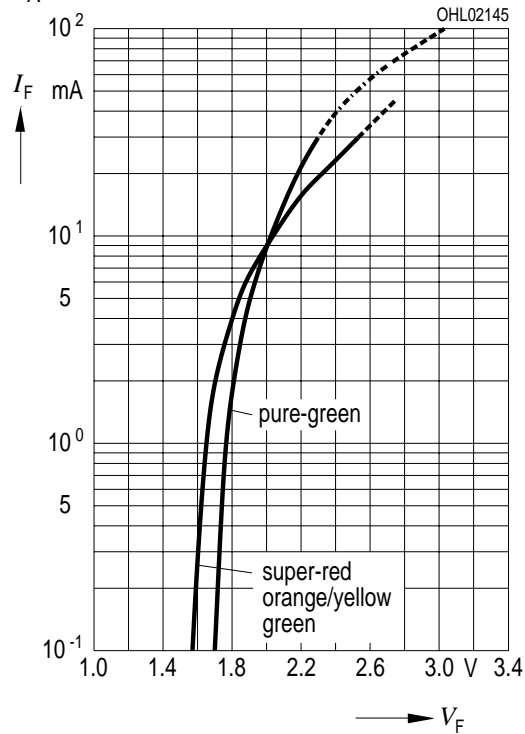

Relative Lichtstärke $I_V/I_{V(10\text{ mA})} = f(I_F)$
Relative Luminous Intensity

$T_A = 25\text{ }^\circ\text{C}$

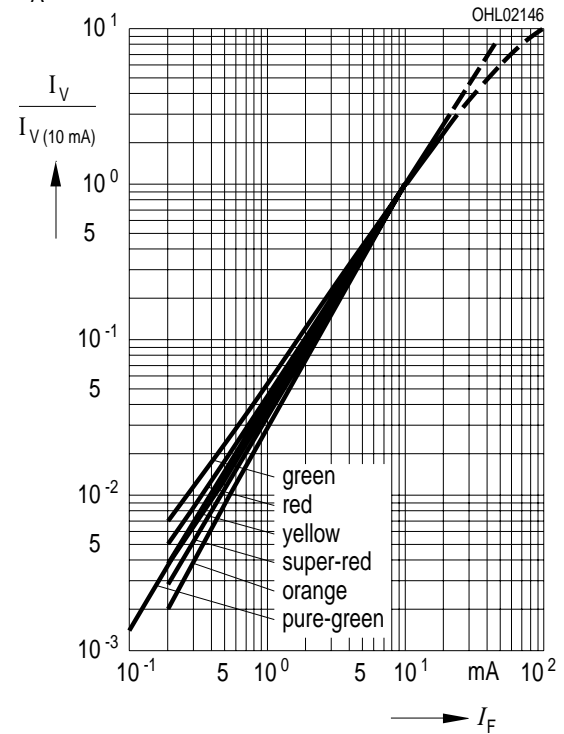

Maximal zulässiger Durchlassstrom $I_F = f(T)$
Max. Permissible Forward Current

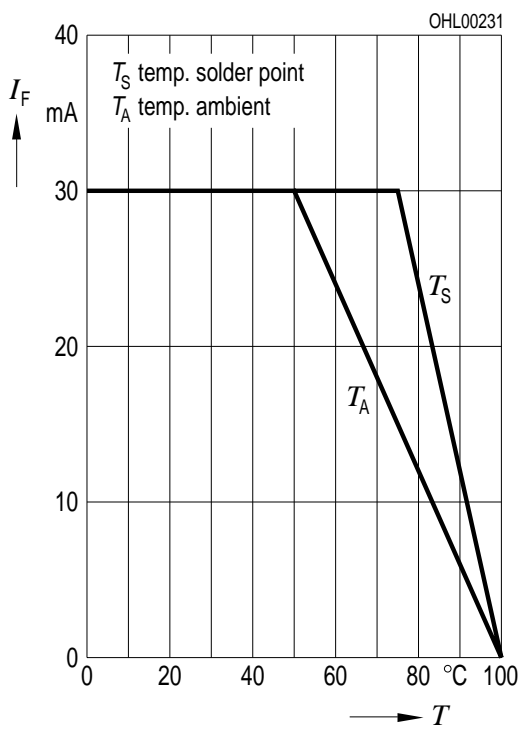

Relative Lichtstärke $I_V / I_{V(25\text{ }^\circ\text{C})} = f(T_A)$
Relative Luminous Intensity

$I_F = 10\text{ mA}$

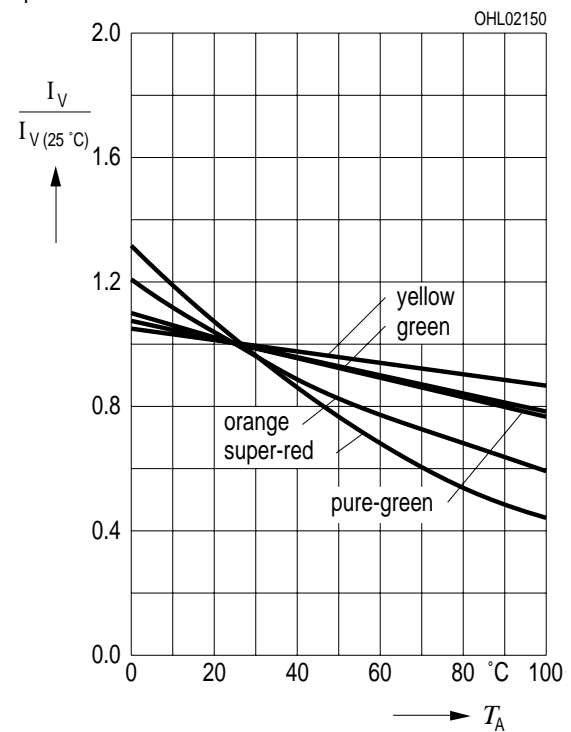

Zulässige Impulsbelastbarkeit $I_F = f(t_p)$
Permissible Pulse Handling Capability

Duty cycle $D =$ parameter, $T_A = 25\text{ °C}$

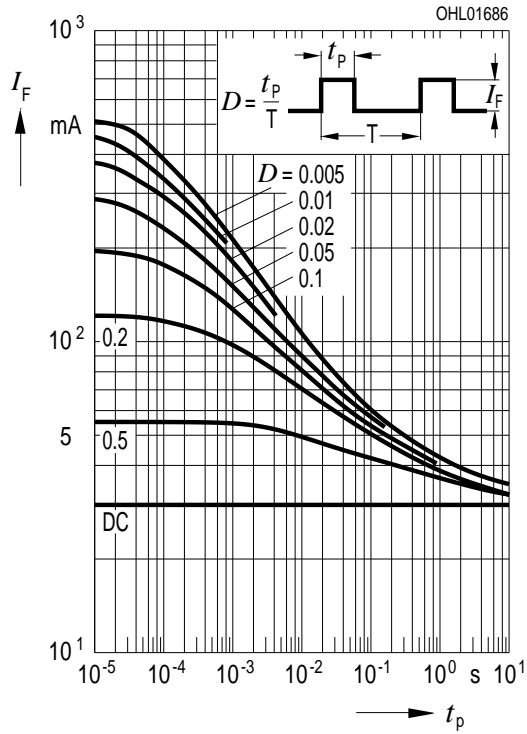

Maßzeichnung
Package Outlines

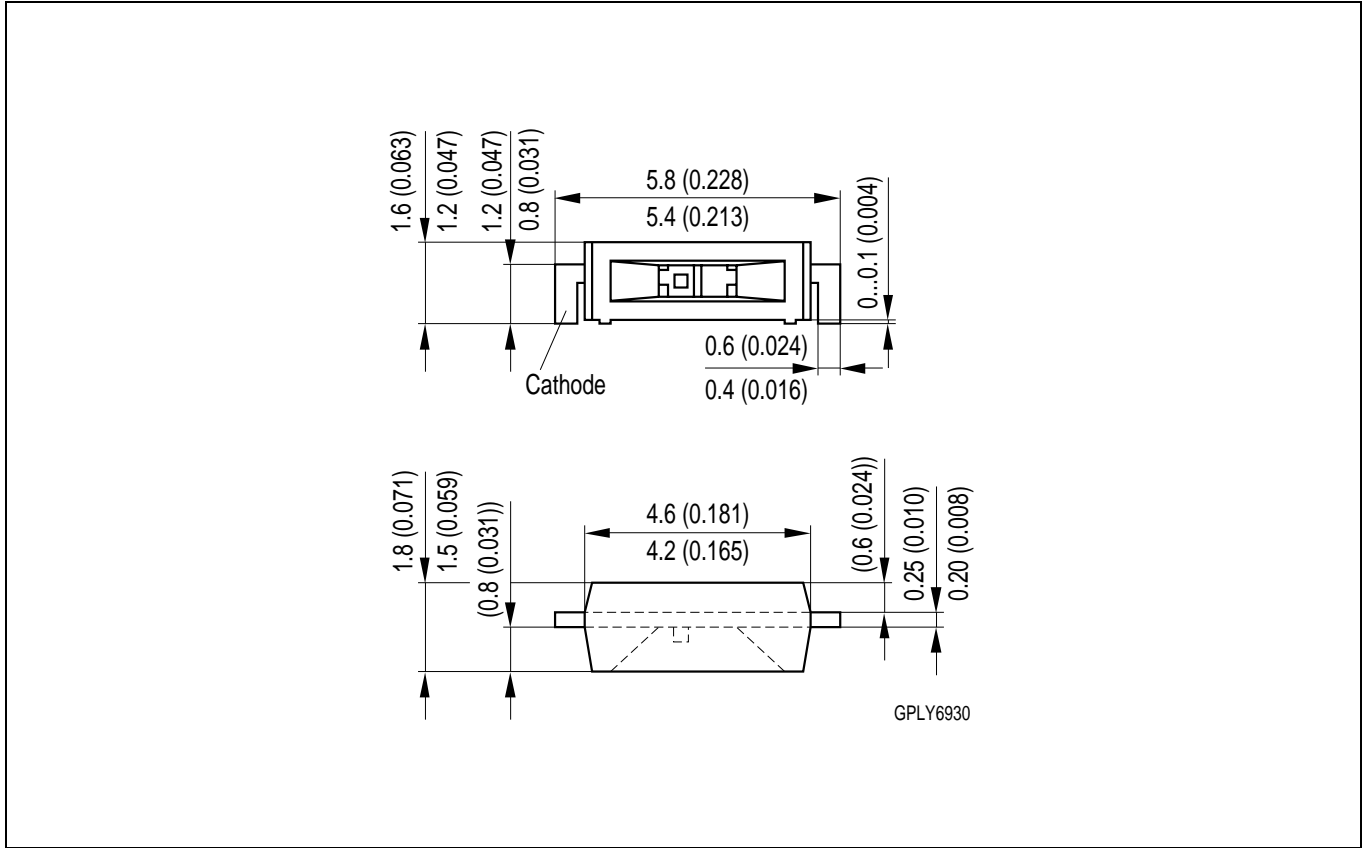

Maße werden wie folgt angegeben: mm (inch) / Dimensions are specified as follows: mm (inch).

Gewicht / Approx. weight: 20 mg

Lötbedingungen Vorbehandlung nach JEDEC Level 2
Soldering Conditions Preconditioning acc. to JEDEC Level 2

IR-Reflow Lötprofil (nach IPC 9501)
IR Reflow Soldering Profile (acc. to IPC 9501)

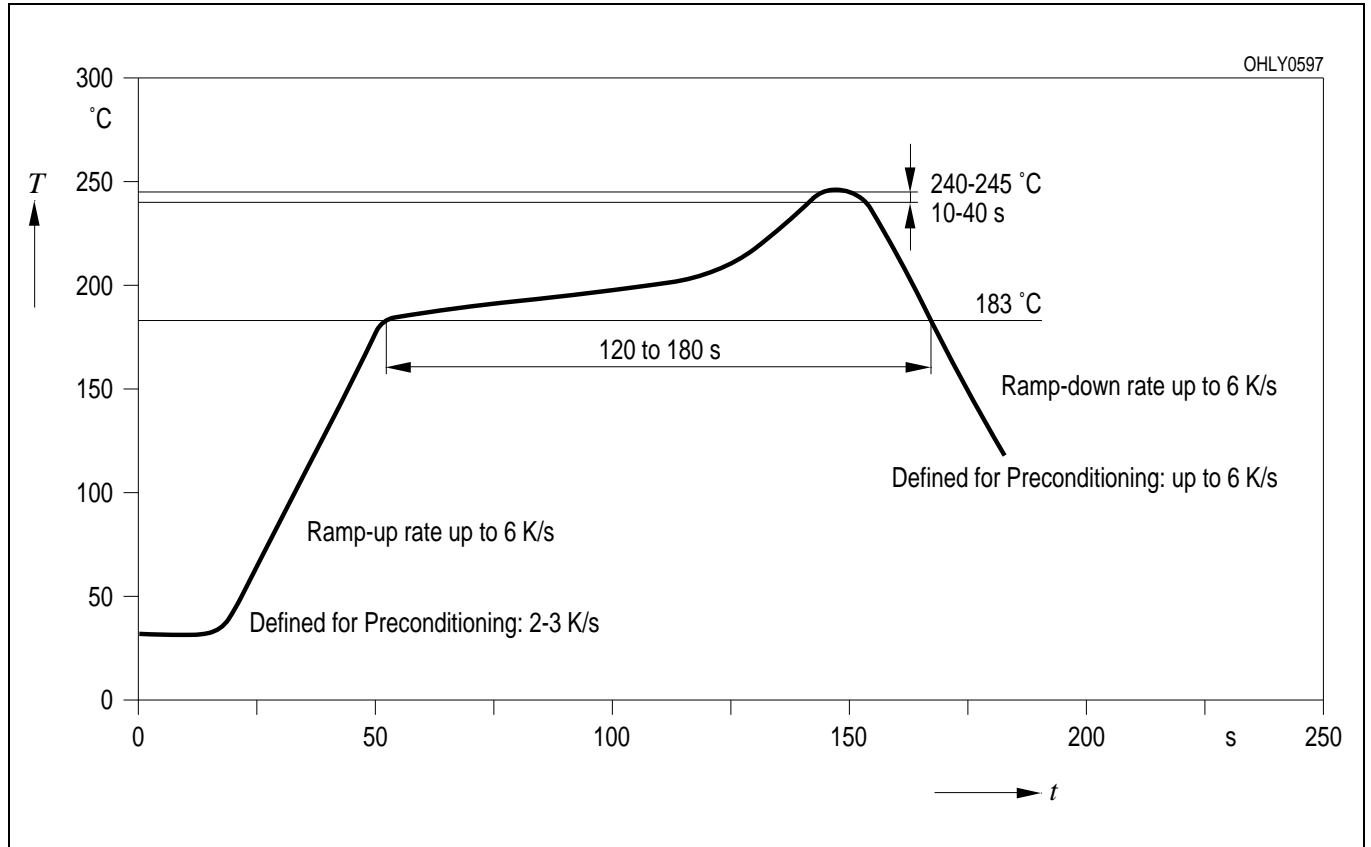

Empfohlenes Lötpad Design IR Reflow Lötén
Recommended Solder Pad IR Reflow Soldering

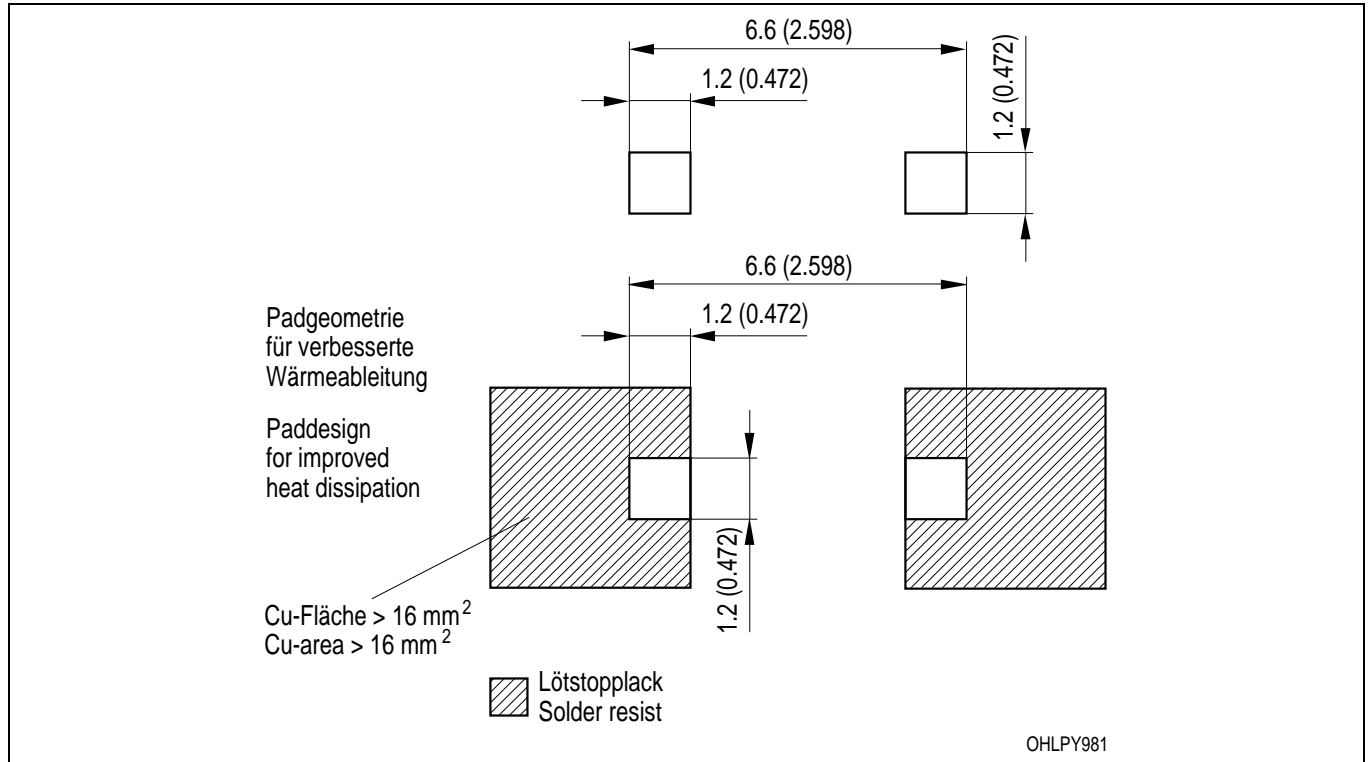

Maße werden wie folgt angegeben: mm (inch) / Dimensions are specified as follows: mm (inch).

Gurtung / Polarität und Lage

Verpackungseinheit 2500/Rolle, ø180 mm oder 10000/Rolle, ø330 mm

Method of Taping / Polarity and Orientation

Packing unit 2500/reel, ø180 mm or 10000/reel, ø330 mm

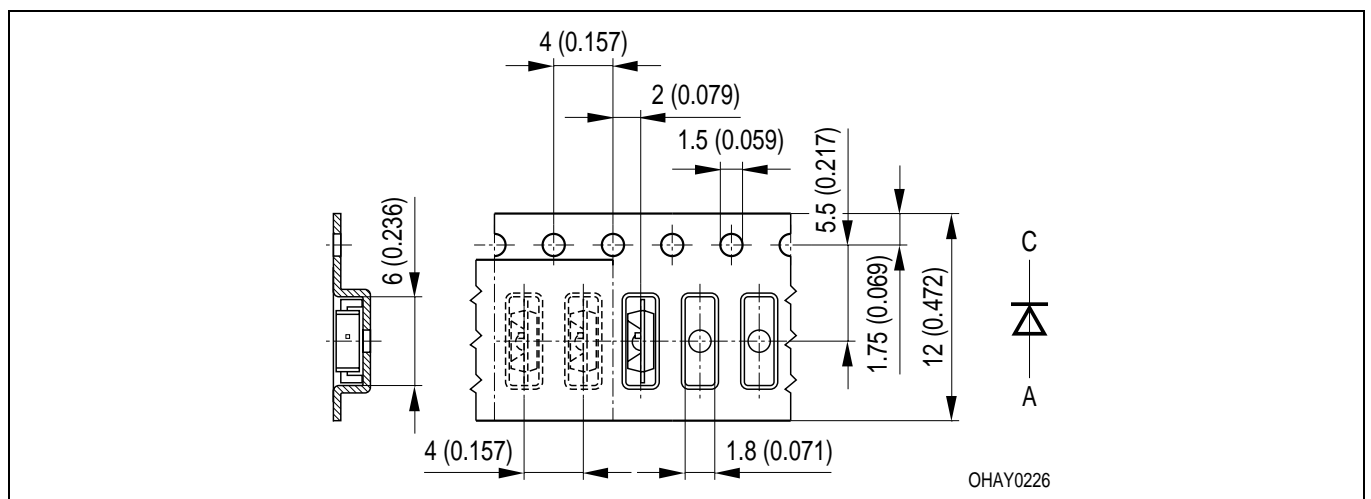

Maße werden wie folgt angegeben: mm (inch) / Dimensions are specified as follows: mm (inch).

Revision History: 2001-02-14

Previous Version: 2001-02-14

Page	Subjects (major changes since last revision)

Published by OSRAM Opto Semiconductors GmbH & Co. OHG

Wernerwerkstrasse 2, D-93049 Regensburg

© All Rights Reserved.

Attention please!

The information describes the type of component and shall not be considered as assured characteristics. Terms of delivery and rights to change design reserved. Due to technical requirements components may contain dangerous substances. For information on the types in question please contact our Sales Organization. If printed or downloaded, please find the latest version in the Internet.

Packing

Please use the recycling operators known to you. We can also help you – get in touch with your nearest sales office. By agreement we will take packing material back, if it is sorted. You must bear the costs of transport. For packing material that is returned to us unsorted or which we are not obliged to accept, we shall have to invoice you for any costs incurred.

Components used in life-support devices or systems must be expressly authorized for such purpose! Critical components ¹ may only be used in life-support devices or systems ² with the express written approval of OSRAM OS.

¹ A critical component is a component used in a life-support device or system whose failure can reasonably be expected to cause the failure of that life-support device or system, or to affect its safety or the effectiveness of that device or system.

² Life support devices or systems are intended (a) to be implanted in the human body, or (b) to support and/or maintain and sustain human life. If they fail, it is reasonable to assume that the health of the user may be endangered.